

Prospecting Manual

BEEP MAT

Model BM4+



INSTRUMENTATION

GDD INC.

Instrumentation GDD Inc.
860 de la Chaudière Blvd.
Québec, Québec, Canada G1X 4B7
Tel.: (418) 877-4249 – Fax: (418) 877-4054

www.gddinstrumentation.com

Visit our web site at:

WWW.GDDINSTRUMENTATION.COM

To:

- Discover GDD's new products.
- Download the latest version of the *Beep Mat* Prospecting Manual.
- Comment on or ask questions about our products.

Write to us at: gdd@gddinstrumentation.com

To reach us out of the normal hours:

Pierre Gaucher, Eng., MBA

General Manager and V.P.

At home: (418) 657-5870

Cell.: (418) 261-5552

or

Régis Desbiens, Eng.

President

At home: (418) 658-8539

Table of contents

PREFACE

QUICK USER'S GUIDE

<i>How to use the Beep Mat</i>	vi
<i>Basic Beep Mat signal interpretation</i>	vii
<i>Beep Mat used with an ATV or snowmobile</i>	viii
<i>In case of a Beep Mat breakdown</i>	ix
<i>Typical profiles of the Beep Mat</i>	xi
<i>Example on what to record in the field: Record to photocopy for field work</i>	xii

1. INTRODUCTION	1
1.1 <i>Brief Description of the Beep Mat</i>	1
1.2 <i>Beep Mat Components</i>	1
1.3 <i>Specifications</i>	2
2. INSTRUMENT TESTING	3
2.1 <i>Charging the Batteries</i>	3
2.2 <i>Detecting Functions and Testing</i>	4
3. READING UNIT	6
3.1 <i>Reading Unit Elements</i>	6
3.2 <i>Beep Mat States</i>	7
3.3 <i>How to Pass From One State to the Other With [ON]</i>	8
3.4 <i>Operating Parameters and Their Thresholds</i>	8
3.5 <i>Sound Control</i>	10
3.6 <i>Reinitialization Time</i>	10
3.7 <i>Record Data</i>	10
3.8 <i>Clear Memory</i>	11
3.9 <i>Troubleshooting</i>	11
4. OPERATING PRINCIPLE	12
5. USE IN THE FIELD	14
5.1 <i>Getting Ready</i>	14
5.2 <i>Initialization</i>	15
5.3 <i>Exploration</i>	15
5.4 <i>Example of Notebook</i>	16

6. INTERPRETATION OF READINGS	17
6.1 <i>Data on a Target</i>	17
6.2 <i>Profiles on Targets</i>	18
7. PRACTICAL APPLICATIONS	21
7.1 <i>Strategy</i>	21
7.2 <i>Advanced Tactics</i>	22
7.3 <i>Case of Anomalies Forming a Doublet</i>	23
7.4 <i>Sampling</i>	24
7.5 <i>Clayey Grounds</i>	24
8. TRUE AND FALSE SIGNALS	25
8.1 <i>Probe Frequency Drift</i>	25
8.2 <i>Drifting and Ground Proximity</i>	25
8.3 <i>How to Interpret Beep Mat Signals in Clayey Areas</i>	25
8.4 <i>Salt in the Ground</i>	25
9. INTERPRETATION OF VALUES	26
9.1 <i>Magnetite Content</i>	26
9.2 <i>Apparent Conductivity</i>	26
9.3 <i>Intrinsic Conductivity</i>	27
9.4 <i>Variation of Sulfides Conductivity</i>	27
10. DATA TRANSFER	28

Preface

With the *Beep Mat*, you can drastically reduce the cost of sampling and assaying the numerous near-surface conductors detected by airborne surveys in the many areas where the overburden is shallow. The *Beep Mat* has also been very successful in discovering new floats of ore and in the follow-up of conductive floats of ore to their source. Finally, the *Beep Mat* has discovered rich showings of gold and base metals that had not responded to airborne EM and even to any geophysical methods, as it can detect even small veinlets in an otherwise non-conductive body.

Under the moss, the *Beep Mat* also detects conductive and magnetic boulders. It is therefore possible to map the scattering of a trail of floats and find its source.

Moreover, the *Beep Mat* is the only instrument capable of detecting sulfide veinlets in suboutcropping ores that would otherwise respond weakly or not at all to geophysics. For example, the *Beep Mat* detected small chalcopyrite and pyrite veinlets in suboutcropping ores of Silidor and New Pascalis mines. Similar mines could be inexpensively discovered by a prospector dragging a *Beep Mat* in the woods and sampling every conductive vein detected.

Not only is the *Beep Mat* a new tool for prospecting, but it is also a whole new way of looking at prospecting!

GDD is convinced that the large-scale use of *Beep Mats* will bring new life to exploration of base and precious metals throughout Canada, just as the large-scale use of the scintillometer did for uranium exploration in Saskatchewan.

How to use the Beep Mat

- A) Connect the probe (*Beep Mat*) to the back of the reading unit.
- B) Press and hold [ON] until the first sound signal stops, then release it. "Standby" will then appear on the display indicating that the probe is connected and warming up. If possible, it is recommended to warm up the instrument at least half an hour before beginning the survey. It is possible to use the *Beep Mat* without warming it. However, the probe won't be stable and once in a while, false signals will probably occur. To avoid confusion in this case, and to confirm the presence of a real conductor, the user will have to re-initialize the *Beep Mat* (see C) and put the probe on the ground over the area where it might have a conductor. If it beeps, there is a real conductor, if not, the probe has given a false signal because it hasn't been warmed up properly (standby).
- C) To begin the survey, you have to put the probe away from any conductive material by lifting it vertically above your head so as to avoid ground effects. To do that, initialize the reading unit by pressing quickly on the [ON] key (pump it once). Until this moment, you will have 4 seconds to put the probe above your head. A Beep will be heard for each of the first 4 seconds. The actual initialization occurs when the two consecutive beeps are heard at the fifth second. The 5-second delay will give the operator the opportunity to pick the probe with his two hands, so as to secure a better grip.
- D) After every 15 minutes of use, the instrument will signal by a repetitive beep and a visual message ("Please re-initialize") that the instrument needs to be reinitialized. The reinitialization procedure is done in order to always achieve maximum efficiency. Repeat step C before continuing the survey. It is necessary to re-initialize the *Beep Mat* periodically. The default reinitialization time is 15 minutes. However, in some special conditions, it may be more practical to increase the re-initialization time to 30 minutes, for example when surveying with an ATV or a snowmobile. To increase the re-initialization time to 30 minutes, press on the [MODE] key twice. The following message will appear on the screen: *15 minutes*. Use either [↑] or [↓] to change the re-initialization time from 15 to 30 minutes, and vice versa. When the 30-minute re-initialization time is chosen, the initialization time will automatically increase from 5 sec. to 20 sec. This delay during the initialization will allow the operator to move behind the ATV or snowmobile, to lift the probe or sleight vertically in the air with his two hands before the two beeps are heard.
- E) To shut off the instrument, press and hold [ON] until OFF appears on the display (about 5 sec.), then release it.



NOTE: If the instrument is not used during two hours, it will automatically turn itself off.

- F) The instrument should be recharged every night from a 110 -V socket or a 12 -V battery (depending of the model). Full charge takes between 4 to 6 hours. When not in use for a long period, do not keep the instrument on charge. The charger is to be connected to the same outlet as the cable of the probe. On demand, GDD can modify the charger to be able to plug it on a 220-V.
- G) [X] key
This key will neutralize the sound signal of the unit for a period of up to 5 minutes. The sound signal will come back if you press this key again , if any other key is pressed or if the 5-minute period is over. NOTE: To indicate that the sound signal has been neutralized, a black rectangle will appear on the display, in the right corner.
- H) The default alarm levels for the *Beep Mat* when you first turn it on are: LFR: 2 Hz, HFR: 4 Hz, MAG: 400 Hz and M.C. 99%. These default parameters should not be changed unless you are an experienced user (If you still need to change them, see section I below). Be aware that if for example one increase the HFR alarm level, it will reduce substantially the depth at which the *Beep Mat* is able to detect a conductor.
- I) To change the value of any parameter, press on [LEVEL] until you see the value you want to change. Once there, press on the arrow keys, [↑] or [↓], to increase or decrease the value of each parameter.
NOTE: If at any time you become confused with those values, just turn the instrument off , then on again to reset all default values.
- J) If the batteries become too weak after a 8 to 10 hours of full work, the reading unit will emit an alarm signal and display the message "Low battery". Shortly afterwards, the readings become meaningless. Charge the batteries the same day.
- K) [MODE] key
This key is used to change the reinitialization time and to adjust the auto -recording time (3,000 readings capacity with the BM4+).
- L) [□] and [■] keys
These two keys are used to adjust the display brightness by pumping them several times.

Basic Beep Mat signal interpretation

LFR and HFR are respectively the Low frequency and the High frequency response. They increase near a conductor. The strength or sulphurs' concentration will be proportional to the HFR/LFR response. On a conductive horizon, the user will prefer to sample where the HFR/LFR values are the highest.

The high frequency (HFR) is always displayed. The low frequency (LFR) is displayed as long as there isn't magnetite. If there is magnetite, the instrument will display MAG instead of LFR.

MAG is the magnetic value and increases in presence of magnetite (its value is negative). As an example, a MAG value of $-1,000 = 1\%$ of magnetite (approximately) and a MAG value of $-10,000 = 10\%$ of magnetite.

Rt is the Ratio value. Rt is unaffected by the amount of conductive material present and qualifies the conductor (intrinsic conductivity) from 0% (poor conductor) to 100% (excellent conductor). See the annexed graph representing an equivalent of the Rt in Mhos/m at the end of the quick user's guide.

NOTE: The Rt is calculated only if no magnetite is present and if HFR is at least 10 Hz. If magnetite is present, $Rt = ***$ will appear on the display.

Beep Mat used with an ATV or snowmobile

The reading unit has been modified so that an optional buzzer can be snapped to the operator's collar. Being located close to the ear, the operator will hear the alarm when a conductor is detected. Action could take place immediately. One can use an optional 12 - 18 foot cable to connect the probe to the reading module. This set up allows the *Beep Mat* to be pulled at up to 20-30 km per hour.

If the user prefers to use a visual signal, the "graph" option will allow to visualize on a graphic the conductive anomaly (peak toward the top of the display) or the magnetic anomaly (peak toward the bottom of the display). To change the display view from the normal view to the graph view, use the horizontal arrows. Take note that if there isn't any magnetic or conductive anomaly, there will be no peak in consequence and it is normal that there will be no graph. The user can settle the speed at which the graph moves from right to left: at each 0,1 or 0,2 or 0,3... to 10 seconds (graph time). This option will allow the snowmobile driver, as an example, to settle his display on different frequency depending of the snowmobile speed.

Make sure that the probe is not next to any metal parts, such as the ATV, the snowmobile or, in some case, the sleigh. To do so, either put the probe in a sleigh made only of wood/plastic, or drag it behind as far as possible from the vehicle. Limit the speed of the vehicle to 20-30 km/h for such a survey.

A new reading module, the BM7+, is now available. It allows the use of an incorporated GPS and an optional MAG. This combination allows to cover large areas, to localize conductors even when travelling at high speeds and to record their position and their intensity within its 400,000 -reading memory (up to 10 times a second). A conductivity and susceptibility map could then be produced from the data recorded. In a second step, one can plan a field trip to explain the nature of the conductor(s) found knowing exactly where they are located.

In case of a Beep Mat breakdown

Connect the probe to the reading unit and initialize the *Beep Mat* far away from any conductive material (step C). If the display indicates "NO HI FREQ. " (No High Frequency) or "NO LO FREQ. " (No Low Frequency), replace the cable. If the unit is still not working, refer to section 3.9: Troubleshooting.

If the instrument is equipped with the new reset fuse, disconnect the cable for 30 seconds then reconnect it and initialize the *Beep Mat* as usual. The fuse is chemical and it takes back its properties. It allows to protect the instrument against static and electric shock but not against mechanical breaking.

If you don't see anything but you hear sounds when you initialize the instrument, you may have to adjust the display brightness ([□] and [■] keys) (see L).

This table and graph show the correlation between the conductivity of a large vat of increasing salt water measured with an IP dipole and the RT ratio measured with a standard model BM 4+.

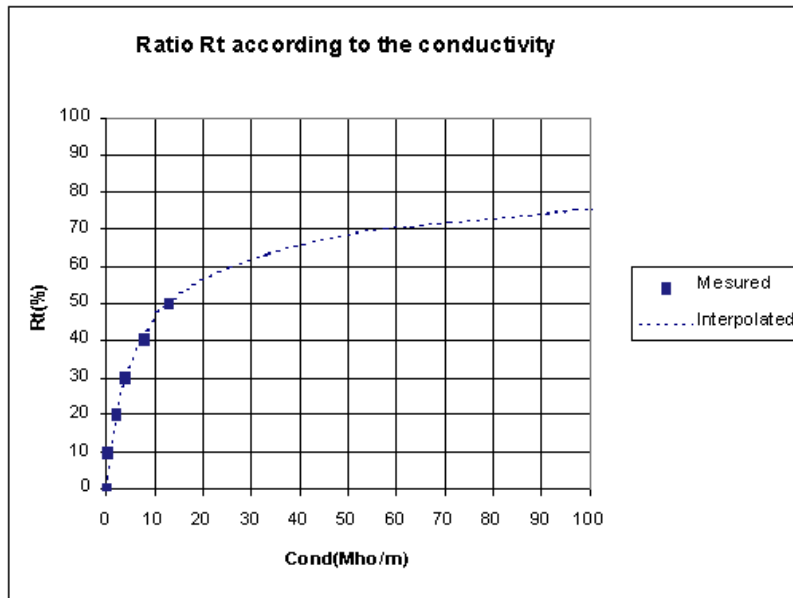

Ratio (%)	Interpolated (Mhos/m)
0	0.00
10	0.40
20	2.00
30	4.00
40	8.00
50	13.00
60	25.64*
70	57.79*
80	174.02*
90	1105.38*
95	6951.18*
100	∞

* The values with an asterisk were interpolated.

Please note that the conductivity thickness of a conductor rises with the width of the conductor. Also, the measure of the conductivity is only valid in the absence of magnetite as a MaxMin survey.

Typical profiles of the Beep Mat

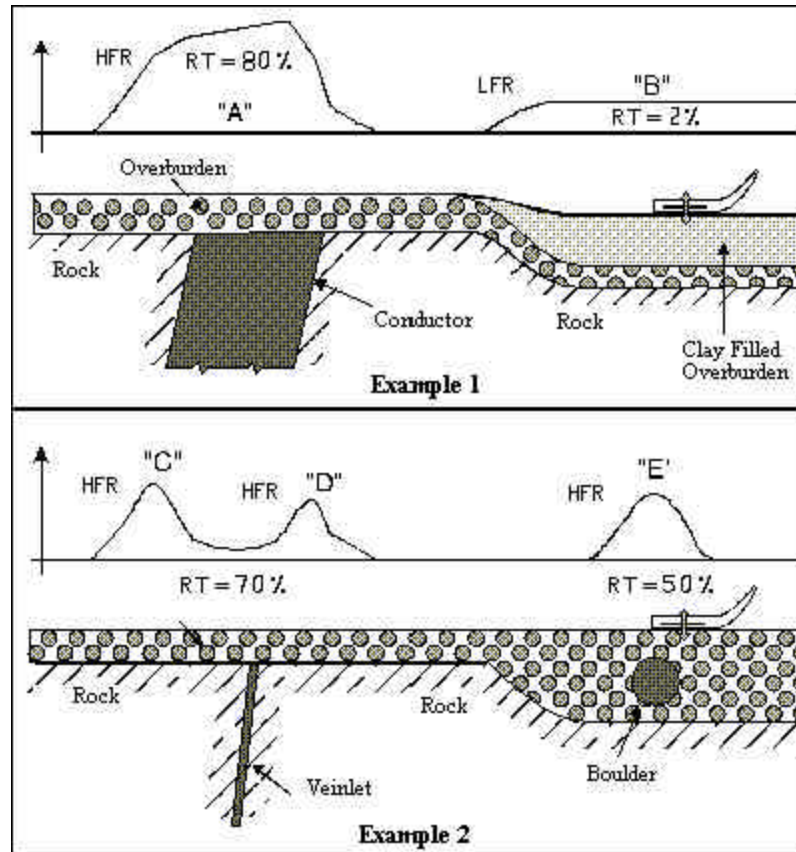

Illustration 10: Examples of typical profiles of the *Beep Mat*

Here is how to interpret illustration 10.

- Anomaly "A" is strong and wide, and the ratio (Rt) is high. It indicates the presence of a **good wide conductor**.
- Anomaly "B", however, is weak and uniform, and the ratio (Rt) is low; it is a typical sign of the effect of a **clayey ground**.
- Examine anomalies "C" and "D" of example 2 above. These two anomalies forming a doublet are both caused by the effect of an almost vertical veinlet. Compare with cases "a" and "b" of illustration 11. There are no anomaly above the **veinlet** because the induction lines (see chapter 4) do not cross it (illustration 11, case "b"). For more explanations, see also illustration 14, at section 7.3.
- Anomaly "E" is rather narrow and reacts mostly in HFR. In this example, it is due to the presence of a **boulder** in the till.

**EXAMPLE ON WHAT TO RECORD IN THE FIELD:
Record to photocopy for field work**

<http://www.gdd.ca>

Échantillon - *Sample #* : _____
 Projet - *Project* : _____ Date - *Date* : _____
 Opérateur(s) - *Operator(s)* : _____

LOCALISATION AVEC GPS - LOCALIZATION BY GPS

NAD 83 EST - *EAST* : _____ m.
 27 NORD - *NORTH* : _____ m.

Zone _____

LECTURES DU BM - BM READINGS

	HFR / LFR	MAG	% RATIO
• Sur la neige : • <i>On top of snow</i> :	_____	_____	_____
• Sol original : • <i>On the surface</i> :	_____	_____	_____
• Sur le roc : • <i>On the conductor</i> :	_____	_____	_____

Profondeur conducteur : _____ m. terre + _____ m. neige
Depth cond. buried : _____ m. soil + _____ m. snow

Dimension conducteur : _____ m. long X _____ m. large
Size of conductor : _____ m. long X _____ m. wide

Site échantillonné : Erratique Affleurement
Site sampled : Boulder Outcrop

Si foré : # de trous _____ Longueur totale _____ m.
If drilled : # of holes _____ Total length _____ m.

Comment échantillonné (cliquez sur la case appropriée) :
Type of sample (tick one appropriate square) :

- | | | |
|--------------------------------------|---|--|
| 1) au marteau :
<i>hammered</i> : | aléatoire <input type="checkbox"/>
<i>random</i> | choisi <input type="checkbox"/>
<i>grab</i> |
| 2) dynamite :
<i>blasted</i> : | aléatoire <input type="checkbox"/>
<i>random</i> | choisi <input type="checkbox"/>
<i>grab</i> |
| 3) poussières de forages | <i>drill cuttings</i> <input type="checkbox"/> | |

Si affleurement lité : Azimut _____ Plongée _____
If outcrop layered : Azimuth : _____ Y Dip : _____ Y

Description du site et de la géologie - *Site and geology description* :

1. INTRODUCTION

This manual is intended for geologists and prospectors. It concerns the *Beep Mat*, model BM4+. However, the general theory of the *Beep Mat* can be used to better understand any previous model.

1.1 *Brief Description of the Beep Mat*

The *Beep Mat* is a simple and efficient electromagnetic prospecting instrument adapted to the search of outcrops and/or boulders containing conductive and/or magnetic minerals. It basically consists of a sleigh-shaped short probe and a reading unit. For prospecting, you pull the probe on the ground to be explored. The *Beep Mat* takes continuous readings while you walk and sends out a distinctive audible signal when detecting a conductive or a magnetic object in a radius of up to 3 meters. The *Beep Mat* directly detects and signals the presence of ores, even slightly conductive, containing chalcopyrite, galena, pentlandite, bornite and chalcocite. It also detects native metals (copper, silver, gold) as well as generally barren conductive bodies (pyrite, graphite and pyrrhotite), but which may contain precious ores such as gold or zinc (sphalerite), which are themselves non-conductive. Besides detecting conductors, the *Beep Mat* measures their intrinsic conductivity and their magnetic susceptibility (magnetite content). This helps geologists and geophysicists better interpret others geophysical and geological surveys.

1.2 *Beep Mat Components*

When you receive your *Beep Mat*, make sure that it contains all components shown on illustration 1. If not, please contact *Instrumentation GDD Inc.* Pay special attention to the terminology used on illustration 1 since it will be used throughout this manual.

The following optional components may also be included:

- a dumping cable;
- an external beeper;
- a protective plate under the shell;
- a 17-foot cable for winter.

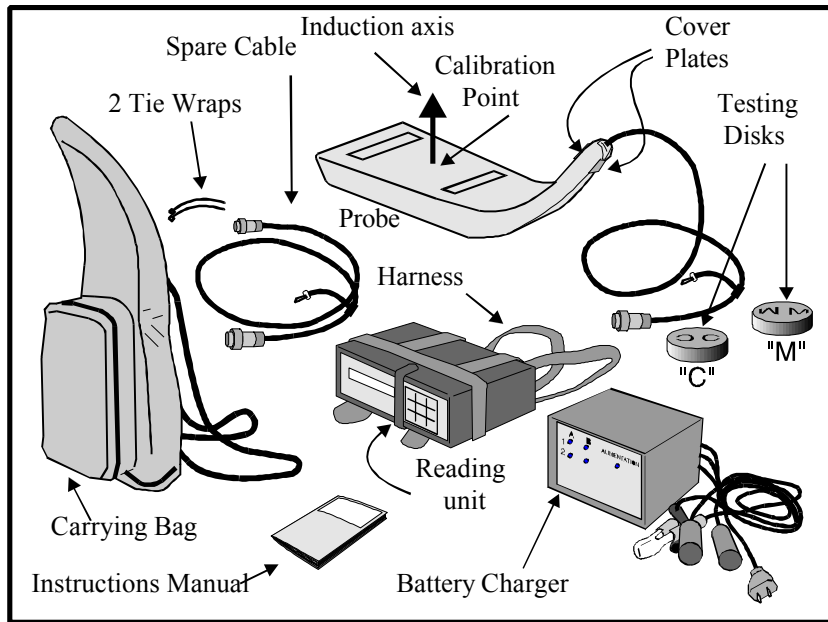

Illustration 1: *Beep Mat* components

1.3 Specifications

Power supply:	2 rechargeable 6-V batteries
Daily autonomy:	up to 10 hours
Memory capacity:	3,300 readings
Weight:	Reading unit: 1.9 kg
	Probe: 3.8 kg
Size:	Reading unit: 18 x 20 x 6.4 cm
	Probe: 30 x 91 x 7.6 cm
Operating temperature:	from -20°C to 40°C
Humidity:	can be operated on rainy, foggy or snowy days

2. INSTRUMENT TESTING

Upon delivery of the *Beep Mat*, always check if the batteries are charged.

2.1 Charging the Batteries

It is recommended to keep the instrument on charge when not in use. The charger (see below) can operate either from a 110 -V socket or a 12 -V battery (ex: car or truck battery).

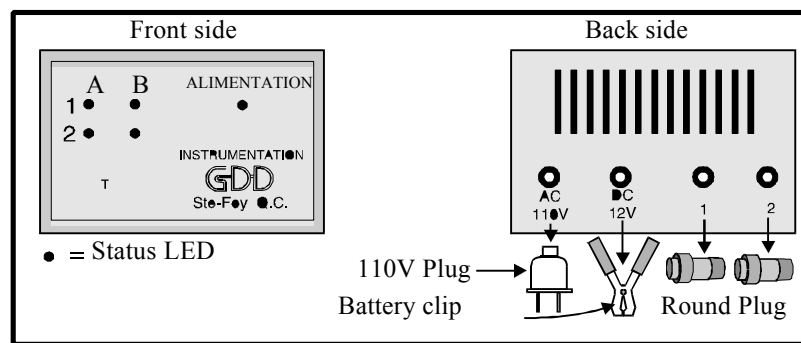

Illustration 2: Battery charger

To charge the *Beep Mat*, connect **one** of the round plugs of the charger to the corresponding round jack at the back of the reading unit (see i llustration 4). Connect the 110-V plug to a socket, or connect the battery clips to the terminal of a 12 -V battery. CAUTION: the red clip must touch only the positive terminal (+) of the battery.

If the ALIMENTATION light does not come on, the power source might be defective or the supply cable might have been cut. Each *Beep Mat* has two batteries, identified "A" and "B". The charger can accommodate two *Beep Mats* on its connectors identified "1" and "2". The corresponding lights on the front of the charger indicate that the batteries are indeed being charged. When the batteries are completely charged, the corresponding lights go out. Disconnect the round plug. The *Beep Mat* is now ready to be used in the field.

IMPORTANT: Never turn on the reading unit when it is connected to the charger as it may damage the charger.

2.2 Detecting Functions and Testing

Connect the probe cable to the round jack at the back of the reading unit. Put the probe in a metal-free environment; for example, place the probe on a **wooden** table or a cardboard box. Ideally, avoid any kind of metal in a radius of 3 meters. On the reading unit, press the [ON] key. An initialization message will be displayed, then the following display will appear:

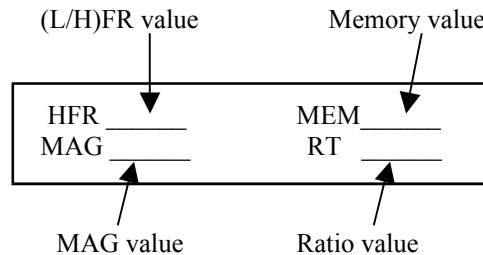

Illustration 3: Typical display on the BM4+ reading unit

The lines "_____" indicate the place where numbers will appear. You might hear one or two sounds coming from the buzzers.

Bring a metal piece close to the probe (ex.: keys or a can). The (L/H)FR value should be positive, and the CONDUCTOR status light (see illustration 4) should light up and you should hear a low-pitched sound. The ratio value should be near 100%, indicating an excellent conductor.

Take away the metal piece from the probe, then place the red testing disk "C" (conductor) in the middle of the testing point (the first "D" of GDD on the probe). The (L/H)FR value should rise while the MAG value should stay near zero. The Rt value should indicate a value around 40%. You should hear the high-pitched sound and the red CONDUCTOR status light should light up.

The displayed values should correspond, by 20%, to the values marked on the red disk "C".

Then take away the red disk "C" and place the blue testing disk "M" (magnetic) in the middle of the testing point. The (L/H)FR value should remain near zero and the MAG value should increase. You should hear a high-pitched sound, and finally, the Rt value should indicate *** (due to the presence of magnetite).

The displayed values should correspond, by 20%, to the values marked on the blue disk "M".

Now, place the red disk on the blue disk in the middle of the testing point. The (L/H)FR value and the MAG value should increase and the Rt value should be ***. You should also hear the high-pitched and low-pitched sounds and the red CONDUCTOR status light should light up.

The displayed values should correspond, by 20%, to the values marked on the red disk "C".

If the *Beep Mat* reacts as described previously, it means that it works well. Otherwise, refer to section 3.9 (Troubleshooting). Repeat that test when you are not sure if the instrument is working well.

Those 3 tests are basic examples of the *Beep Mat* response in the field, so try to become very familiar with them.

- The reaction to the red disk is the typical reaction of the *Beep Mat* when you pass over a conductor in a non-magnetic environment.
- The reaction to the blue disk is the typical reaction of the *Beep Mat* when you pass over a magnetic body or a magnetic environment.
- The reaction to the red and blue disks is the typical reaction of the *Beep Mat* when you pass over a conductor in a magnetic environment.

3. READING UNIT

This chapter describes the various physical and functional components of the reading unit as well as instructions on how to use them.

3.1 Reading Unit Elements

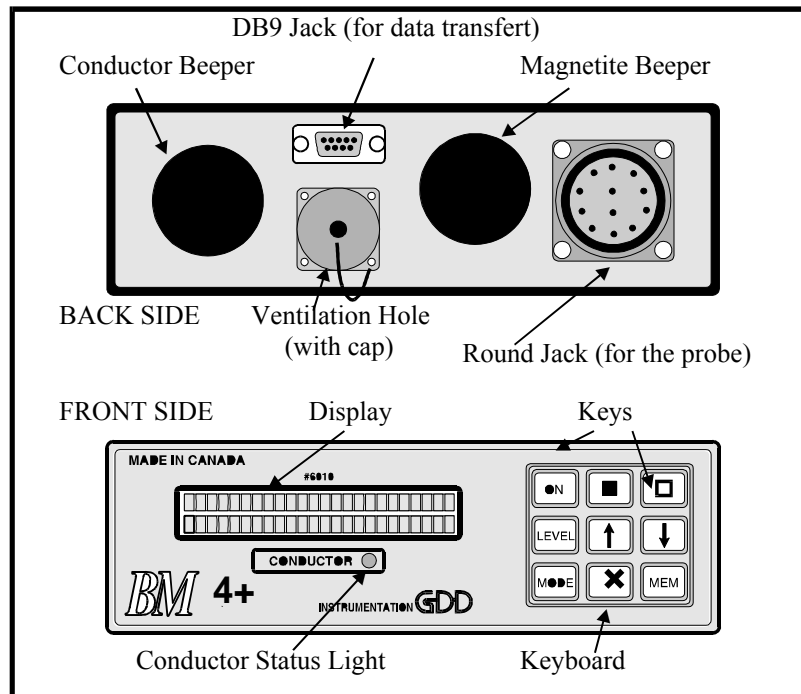

Illustration 4: Reading unit

Illustration 4 shows the various visible parts of the reading unit. Here is a short description of the function of each one.

- The **display** has two lines of 24 characters each. Values, parameters or messages generated by the *Beep Mat* can be read on it.
- The **conductor status light** lights up when the (L/H)FR value exceeds a specified threshold due to the presence of a conductor.
- The **conductor beeper** (low-pitched sound) is activated when the (L/H)FR value exceeds a specified threshold due to the presence of a conductor.
- The **magnetite beeper** (high-pitched sound) is activated when the MAG value exceeds a specified threshold. **N.B.:** the buzzers and the conductor status light react quicker than the display.
- The **round jack** links the reading unit to the probe or to the battery charger.

- The **ventilation cap** covers the ventilation hole. After having worked in rain or any other conditions where there was a high level of humidity, open the cap while the batteries are charging to let humidity out. If possible, do it in a warm and dry place.
- The **DB9 jack** links the reading unit to a computer for the transfer of memorized data.
- The **keys** on the **keyboard** are used to access the various functions of the *Beep Mat*, each key being identified at its center. In this manual, a word or a symbol in brackets represents the key so identified: for example, [ON] or [■], or [↓]. Here are their specific functions:
 - [ON] = To turn on the *Beep Mat* or change its *state*.
 - [□] or [■] = To increase or decrease the display brightness.
 - [LEVEL] = To activate the display of an *operating parameter*.
 - [MODE] = To change the initialization time from 15 to 30 minutes or to adjust the *auto-recording* time.
 - [X] = To neutralize the sound.
 - [MEM] = To store the data or to activate the *auto-recording*.
 - [↑] or [↓] = To increase or reduce the value of the displayed parameters.

The expressions in *bold-italic* as well as the [X], [MODE] and [MEM] keys will be explained in the next sections.

3.2 *Beep Mat States*

The reading unit can be in one of the following four states:

Off

Standby (or preheating)

Initialization

On (in reading process)

- **Off:** The *Beep Mat* stops all functions.
- **Standby:** The *Beep Mat* warms up to stabilize its frequency. The minimal preheating period suggested before beginning a survey is 30 minutes. If possible, preheating should be done under the same temperature conditions expected during the survey.
- **Initialization:** During initialization, the *Beep Mat* adjusts its signals in order to display zero values when there are no conductors. Initialization automatically ends two seconds after [ON] has been pressed.
- **On:** The *Beep Mat* measures the probe reactions, interprets them in terms of values, then displays these values every second. However, the buzzers react instantly, in less than 0.15 second. Therefore, the buzzer might signal something while the reading unit does not display anything. When the *Beep Mat* is *on*, a

message on the display and a sound signal remind the operator to reinitialize the *Beep Mat* at every 15 or 30 minutes.

3.3 How to Pass From One State to the Other With [ON]

[ON] is not only used to turn the *Beep Mat* on; it is also used to put the *Beep Mat* in one of the states described at 3.2. By connecting the probe to the reading unit, the *Beep Mat* is *off*. Every time you momentarily press [ON], the *Beep Mat* passes to *initialization*. After 2 seconds, it passes to *on*. If the key board is not used during more than two hours, the *Beep Mat* automatically passes to *off*.

If you keep [ON] pressed longer, the display indicates the following available states in this order (a few seconds per choice):

Initialization:	(sound signal)	2 seconds
Standby:	(silence)	3 seconds
Off:	(second sound signal)	5 seconds

The *Beep Mat* will put itself in the displayed state if you release [ON] at the precise moment when the state you selected is displayed.

3.4 Operating Parameters and Their Thresholds

The operating parameters of the *Beep Mat* as well as their thresholds when you turn the instrument on are:

	Threshold	Scale
LFR (conductivity)	2 Hz	1-2-4-8-15-20-40-80-150-200-...20,000 Hz
HFR (conductivity)	4 Hz	1-2-4-8-15-20-40-80-150-200-...20,000 Hz
MAG (magnetite)	400 Hz	1-2... 40-80-150-200- 400 -800-...20,000 Hz
M.C. (magnetite coefficient)	99%	103-102-101-100- 99 -98-97-96-94-...70%

To display one of these parameters, press on [LEVEL]. The parameter is only displayed a few seconds, then the display returns to the normal operating mode. By pressing [LEVEL] again during these few seconds, the next parameter is displayed, according to a cyclic sequence. It is possible to modify the displayed parameter with the help of the [↑] and [↓] keys.

It is important to remind that when a value exceeds its threshold, an alarm (sound signal) will go off. By reducing the threshold of a value, the sensitivity of the *Beep Mat* will increase, but also the number of false alarms. On the opposite, by increasing the threshold of a value, the sensitivity of the *Beep Mat* will diminish, as

well as the number of false alarms. Usually, it is not recommended to increase the thresholds because fewer conductors might be found in a day.

Table 1 shows the readings variations of a *Beep Mat* versus the depth of a conductor located under the probe. With this table, you are now able to evaluate what may result from the modification of the thresholds.

Table 1: (L/H)FR value versus depth for a pyrrhotite boulder of 15 cm in diameter

Depth in cm	(L/H)FR Value (conductor)	MAG Value (magnetite)
30	68	0
25	124	0
20	240	0
15	530	0
10	1,329	0
5	3,312	0
0	9,233	0

M.C. Parameter

The M.C. parameter stands for Magnetic Coefficient. It is a correction coefficient for the effect of magnetite that enables the *Beep Mat* to adjust the effect of magnetite versus the effect of a conductor. If you reduce that coefficient, the LFR value will be diminished by the presence of magnetite. The LFR value would therefore become non significant with a too small magnetite coefficient. For this reason, one must be very experienced before modifying that coefficient. The magnetite coefficient must normally be at 99% or 100%. It is sometimes possible to reduce it slightly (ex.: 96%) if the ground is highly magnetic and irregular and if, at 100%, it causes several false alarms.

Generally speaking, it is strongly recommended not to modify the operating parameters unless there are false alarms in repetition. For 95% of the field surveys, the *Beep Mat* will work just fine with all the default parameters preset by GDD.

Remember that if you modify too many thresholds and get confuse with all the values, you can always turn the *Beep Mat* off then turn on again. This will reset all default parameters.

3.5 *Sound Control*

As mentioned at section 3.4, when the thresholds for (L/H)FR or MAG are reached by the *Beep Mat*, an alarm goes off. Sometimes, when you investigate the same conductor longer, the alarm may become bothersome. It is possible to neutralise the alarm with the [X] key. Press the [X] key and a black rectangle will appear at the bottom right of the display to indicate that the alarm has been neutralized. By pressing the [X] key again, the black rectangle will disappear and the alarm will be reactivated. Note that by pressing on [MODE], [LEVEL] or [MEM], the alarm will be automatically reactivated. Also, if you forgot to reactivate the alarm, it will automatically go off after a lapse of 5 minutes.

3.6 *Reinitialization Time*

It is necessary to reinitialize the *Beep Mat* periodically. The default reinitialization time is 15 minutes. However, in some special conditions, it may be more practical to increase the reinitialization time. It is possible, but generally not recommended to do so.

To increase the reinitialization time to 30 minutes, press on the [MODE] key twice. The following message will appear on the display: *15 minutes*. Use either [↑] or [↓] to change the reinitialization time from 15 to 30 minutes, and vice versa.

3.7 *Record Data*

With the BM4+, it is possible to store the values shown on the display. Those values can be stored either manually (Manual recording) or automatically (Auto-recording).

Auto-recording time

By pressing on [MODE], the message *memory time: 0 sec* will be displayed. With the [↑] and [↓] keys, you can modify the time to the value wanted. The 0 time is selected for Manual recording of data while any other values should be selected to allow the Auto-recording.

- **Manual recording** (memory time: 0 sec)

To store the current displayed values, simply press on [MEM].

- **Auto-recording** (memory time: X sec)

The time selected at *memory time* determines the time interval at which the BM4+ will record data automatically. To activate the Auto-recording, press on [MEM]. The # symbol will thus appear at the top right of the display to indicate that the *Beep Mat* is actually storing values automatically at every X sec. To stop the Auto-recording, simply press on [MEM] again (the # symbol will disappear).

Every time the *Beep Mat* stores a value, a number briefly appears beside MEM on the display to indicate the corresponding memory number. Take note that the maximum number of readings that can be stored is 3,300. In your field book, note that number and the conditions in which the reading was taken (see section 5.4 for an example of a typical field book entry). You can later transfer those data to a computer in order to draw a map of the discovered showings or for a geophysical survey (see chapter 10 - Data Transfer).

3.8 *Clear Memory*

It is necessary to do a Clear Memory if one of the following messages appears on the display: *Memory full* or *Memory corrupted*.

If you want, you can erase ALL the memory in the *Beep Mat* while in the field. To do so, press and hold [MEM] and [ON] simultaneously until the message *please wait 15 sec* appears on the display. After 15 seconds, the *Beep Mat* will turn itself off and the memory will be completely empty.

3.9 *Troubleshooting*

If the instrument does not display anything, first check the display brightness with [□] and [■]. Then, turn off the reading unit, then turn it on (to reset all default parameters).

If the *Beep Mat* is incoherent or if the reading unit indicates a problem such as *Low Battery*, *NO HI FREQ.* (No High Frequency) or *NO LO FREQ.* (No Low Frequency), one of the following components might be defective:

- probe cable
- battery charger
- reading unit
- batteries
- probe

In order to try to solve the above problems, first check if the probe cable is correctly screwed on to the reading unit. Then check if the batteries are correctly charged by using either the other cylindrical connector of the charger or another charger (see section 2.1 for a description of the charger). If the instrument is still not working, try a Clear Memory (section 3.8). If the problem persists, replace the probe cable, it may be damaged inside. To replace it, unscrew the screws of the cover plates (see illustration 1). Then, unscrew the connector located there with a pair of pliers and cut the tie wraps if necessary. Connect the spare cable to the same hole where the defective cable was and test it. If it works, put the tie wraps back (it is essential), then put the cover plates back in place. The *Beep Mat* may also display the presence of a problem such as a low battery or non-working elements.

If you are not sure what the problem is, repeat the test described at section 2.2. If the *Beep Mat* still does not work, call *Instrumentation GDD Inc.* so that arrangements can be taken to ship you another unit as soon as possible while the instrument is under repair. Always return the complete instrument with all its components in its carrying bag to GDD.

4. OPERATING PRINCIPLE

The probe contains an inductive coil within its shell. When the probe is in normal position on the ground, as shown on illustration 5, the induction axis sent by the coil is in vertical position.

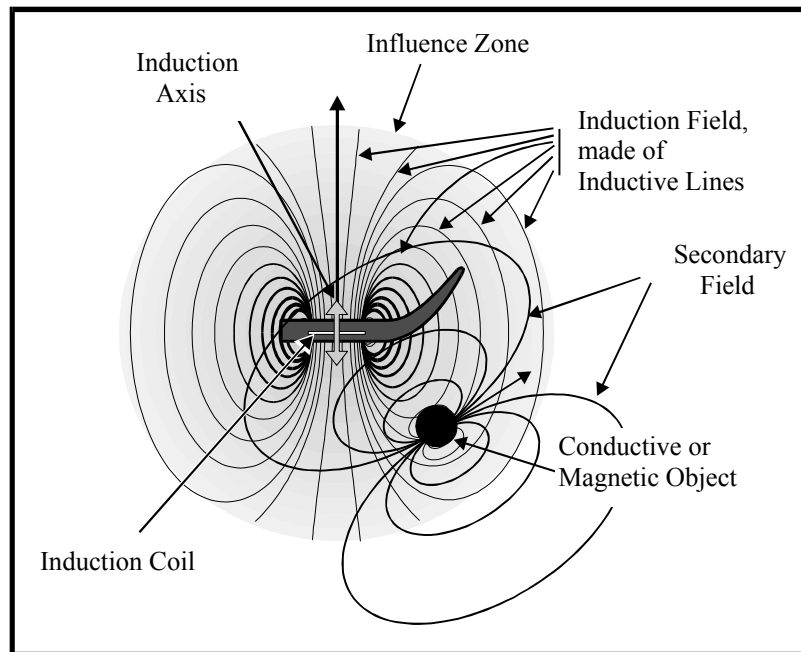

Illustration 5: Operating principle

The influence zone of its induction field has an average radius (called "range") of about 3 meters. This field is similar to the field of a magnet. Any conductive or magnetic object within the zone reacts by sending out again a secondary field (or "induced field") which is weaker and has distinctive features. The probe reacts on the part of this field that goes through its inductive coil. This reaction is then displayed on the reading unit in terms of LFR, HFR, MAG and Rt values.

Picture the inductive field as being composed of several induction lines crossing the inductive coil and which density increases towards the center of the coil. To illustrate that, only a few induction lines are presented on illustration 5. Therefore, the greater the number of lines that cross the conductive or magnetic object, the higher the displayed values will be. For further details, refer to chapter 6.

Following is the meaning of **LFR**, **HFR**, **MAG** and **Rt** values:

- The **LFR** value (Low Frequency Response) represents a specific reaction of the low frequency, in hertz, to the presence of a conductor near the probe.
- The **HFR** value (High Frequency Response) represents a specific reaction of the high frequency, in hertz, to the presence of a conductor near the probe.
- The **MAG** value (Magnetite) represents a specific reaction of the probe, in hertz, to the presence of a magnetic body, in particular one containing magnetite (relative susceptibility).
- The **Rt** value (Ratio) indicates the quality of the conductor (intrinsic conductivity) and is independent of the quantity of present material. For the ratio value to be calculated by the unit, there are two conditions:
 - the HFR must be of at least 10 Hz ;
 - no magnetite must be present (MAG = 0).

In presence of magnetite, the Rt value is altered and $Rt = ***$ will be displayed. When HFR is below 10 Hz, the Rt value is not precise enough and $Rt = 0\%$ will be displayed.

To help you better interpret those values, a practical example is given on illustration 10 (section 6.2).

5. USE IN THE FIELD

This chapter describes a typical sequence for a *Beep Mat* survey.

5.1 Getting Ready

Prepare all the necessary field gear: *Beep Mat*, a GPS if possible to localize yourself and maybe a VLF (EM -16) electro magnetometer to localize airborne conductors, radio, field books, sample bags, small shovel, hammer, flag tape, maps, photos, dynamiting kit, marker, compass, etc.

Make sure that the batteries are charged. If possible, at least 30 minutes before beginning a *Beep Mat* survey, connect the probe cable to the round jack on the reading unit, then put the instrument in *standby* by keeping [ON] pressed until the end of the first sound signal (3 seconds). The message STANDBY will appear. You can carry the instrument while in *standby*, but it is better to keep the probe at least 6 inches away from any large metallic surfaces (i.e., the floor of a truck). In such a situation, it is recommended to put the probe upside down.

It is better that the probe be preheated before beginning a survey. However, even if the probe has not been sufficiently preheated, you can start the survey anyway, but once in the field, you will probably have to reinitialize the *Beep Mat* more often during the first hour of use. Put the probe on the ground, strap the reading unit to yourself and attach the strain relief ribbon to the leather case as shown on illustration 6. You can then initialize the *Beep Mat* (see section 5.2).

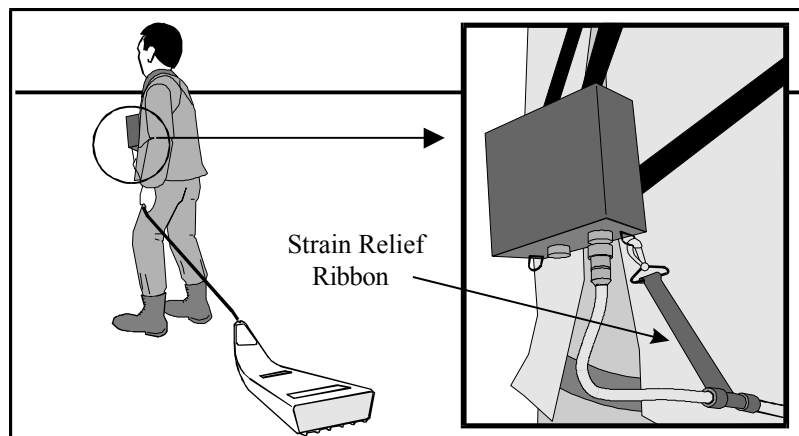

Illustration 6: Typical use of the *Beep Mat*

5.2 Initialization

First, make sure you are not wearing a metal helmet. Lift the probe vertically above your head, as shown on illustration 7, so that it is not affected by the ground, and initialize the *Beep Mat* by pressing on [ON]. Wait until the initialization is over (about 2 sec.), then put the probe on the ground. You can now pull it again. Remember that every 15 minutes, the *Beep Mat* will signal to the operator that it needs to be initialized again. It is possible to initialize the *Beep Mat* anytime by lifting the probe vertically in the air (see illustration 7).

5.3 Exploration

Cover all grounds that you think may offer an interesting potential of discovery. A distinctive signal will indicate that you just passed near a conductor or a magnetite concentration. Stop and confirm the signal position. Mark that position immediately with flag tape, posts or branches. Before digging, reinitialize the probe in the air, then use the *Beep Mat* to delimit the nearby surface giving abnormal readings. Dig at the place where the readings are the highest, that is where there seem to be the most sulfides in the rock. Make sure that it is not caused by scrap metal, such as cans or metal casing (near a former drilling site for example). Dig with a shovel and examine the samples. Try to find the geological cause. You can also use the *Beep Mat* to delimit a conductive or magnetic outcrop.

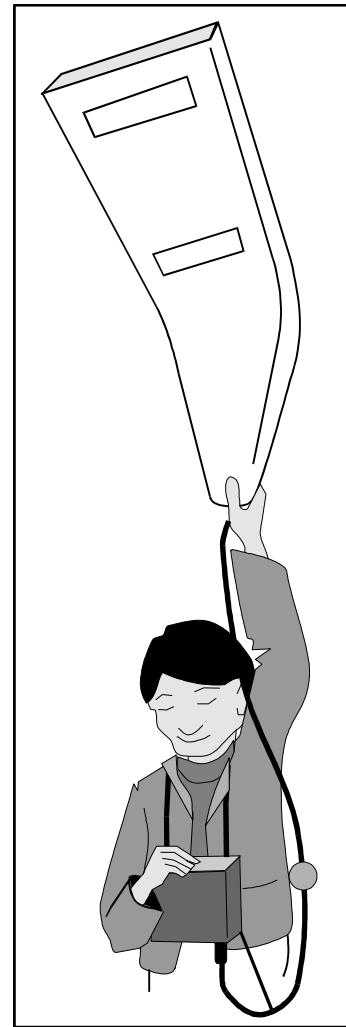

Illustration 7:
Beep Mat initialization

Such exploration helps making discoveries, but in order to increase chances of success, it is recommended to elaborate a strategy and use different tactics. This aspect will be treated further in this manual.

5.4 Example of Notebook

With the *Beep Mat*, you will find a lot of conductors. For a good evaluation of each conductor found, it is important to take proper notes in your notebook. Here is an example of a typical notebook and at the bottom, once transferred in an Excel format

http://www.gdd.ca

Échantillon - Sample #: _____
 Projet - Project : _____ Date - Date : _____
 Opérateur(s) - Operator(s) : _____

LOCALISATION AVEC GPS - LOCALIZATION BY GPS

NAD 83 EST - EAST : _____ m.
 27 NORD - NORTH : _____ m.
 Zone _____

LECTURES DU BM - BM READINGS

	HFR / LFR	MAG	% RATIO
• Sur la neige : • On top of snow :	_____	_____	_____
• Sol original : • On the surface :	_____	_____	_____
• Sur le roc : • On the conductor :	_____	_____	_____

Profondeur conducteur : _____ m. terre + _____ m. neige
 Depth cond. buried : _____ m. soil + _____ m. snow
 Dimension conducteur : _____ m. long X _____ m. large
 Size of conductor : _____ m. long X _____ m. wide

Site échantillonné : Erratique Affleurement
 Site sampled : Boulder Outcrop

Si foré : # de trous _____ Longueur totale _____ m.
 If drilled : # of holes _____ Total length _____ m.

Comment échantillonné (cliquez sur la case appropriée) :
 Type of sample (tick one appropriate square) :

1) au marteau : aléatoire choisi
 hammered : random grab
 2) dynamite : aléatoire choisi
 blasted : random grab
 3) poussières de forages drill cuttings

Si affleurement lité : Azimut _____ Plongée _____
 If outcrop layered : Azimuth _____ Dip _____

Description du site et de la géologie - Site and geology description : _____

Chemical Assays
(will be obtained later)

A	B	C	D	E	F	G	H	I	J	K	L	Au (ppb)	Cu (ppm)	Ni (ppm)
#	pros	B/O	HFR before	HFR after	MAG	Rt %	Area	Orient.	UTM m.N.	UTM m.E.	Comments			
201	LG	B	9,500	45000	3,000 3%	***	0.5 m, round	-	4,986,452	717,540	about 30% of pyrrhotine	>5	34	13
202	EG	O	2,000	4,000	0	55	30 m x 1.5 m	90 N	4,987,022	717,870	lots of small parallel veinlets. Cpy 10%	8,980	5,340	450
203	GD	B	1,200	3,000	2,000 2%	***	0.6 m x 0.4 m	-	4,986,110	716,983	look like quartz with dark impurities.	>5	14	12
301	EG	B	70	1,500	2,500 2.5%	*. **	0.3 m, round	-	4,984,440	718,393	5% Po and 2% Cu	67	2,300	45
302	EG	O	80	6,000	0	54	25 m x 1 m	60 N	4,984,350	718,408	many stripes of conductors about 1 m apart, over 25 m.	550	670	550

- | | |
|---|--|
| A: Sample number | G: Ratio read over the conductor |
| B: Initials of the person who found the sample, for further reference | H: Area over which the <i>Beep Mat</i> responds (beeps) |
| C: The conductor is a boulder (B) or an outcrop (O) | I: Conductor orientation, useful for geological interpretation |
| D: Maximum value (HFR) obtained from the <i>Beep Mat</i> before digging | J-K: Localization of the discovery (here from a GPS in UTM) |
| E: Maximum value (HFR) obtained from the <i>Beep Mat</i> after digging | L: Other useful info, if possible, ore content |
| F: MAG value | |

6. INTERPRETATION OF READINGS

This chapter explains how to interpret the values on a target and the profiles of these values.

6.1 Data on a Target

The (L/H)FR and MAG values are influenced by the conductivity of an object and its magnetite content. A LFR value indicates that the object is more magnetic than conductive, while a HFR value indicates the opposite. A conductive and magnetic rock could give a (L/H)FR value according to the proportion of those elements. The bigger the object is or the closer it is to the probe, the higher the value. The presence of humidity in the ground causes the addition of an offset of 0 to -100 to the MAG value (see illustration 8). For that reason, in the absence of conductors, the readings are generally LFR.

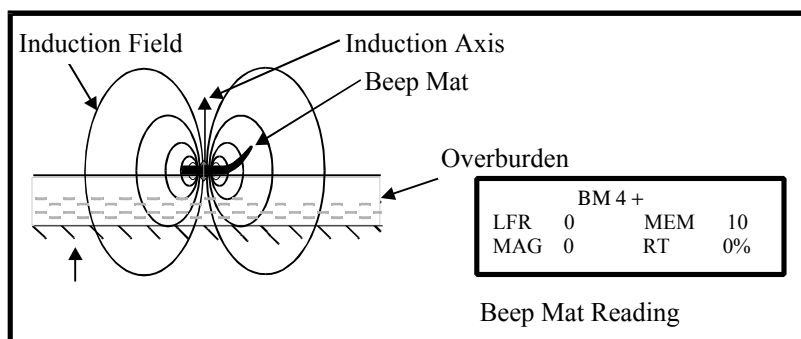

Illustration 8: Typical reading without any anomaly

The HFR corresponds to the variation of the high frequency and the LFR corresponds to the reaction of the low frequency. When approaching a magnetite rich sample (for example, a vein), the low frequency reacts more than the high frequency, so the LFR value should appear and stay at zero or very low. The MAG value increases in negative value (see illustration 9, case "b"). When approaching a conductive sulfide sample, the HFR reacts more than the LFR. Therefore, the HFR value should appear and increase while the MAG value should remain low (see illustration 9, case "a"). If the HFR value is high and the MAG value is low, it means that the conductivity of the sample is high and that the body could turn out to be metal.

Note the similarity of these reactions with those observed during the instrument testing (chapter 2). The weaker the block conductivity is, the weaker the HFR value will be. By approaching a conductive block that also contains magnetite, the LFR will increase and the MAG will diminish in negative value (see illustration 9, case "c").

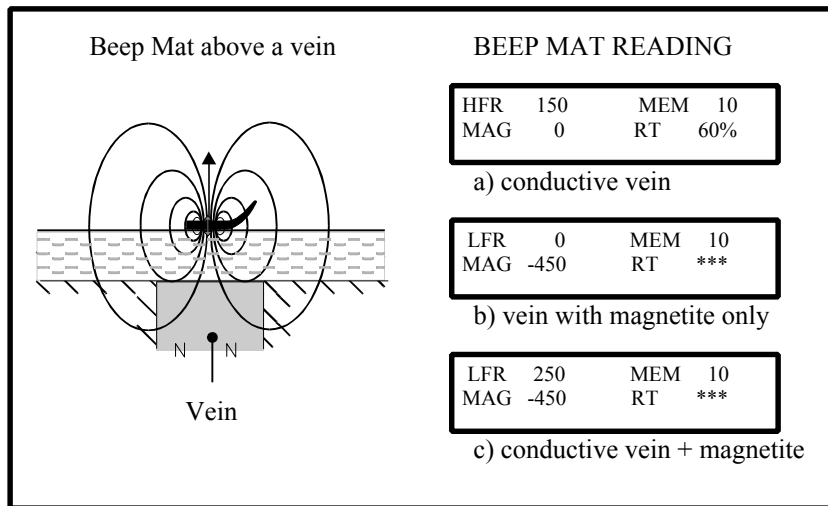

Illustration 9: Examples of *Beep Mat* readings in presence of:
a) a conductor, b) magnetite, c) a conductive body containing magnetite.

6.2 Profiles on Targets

It is possible to draw a profile of the values displayed by the *Beep Mat* along a traverse, but it is rather suggested to just make an image of it in your mind.

Illustration 10 shows two simplified but typical examples. Compare it to illustrations 8, 9 and 11. By studying these illustrations, you should be able to interpret the profiles.

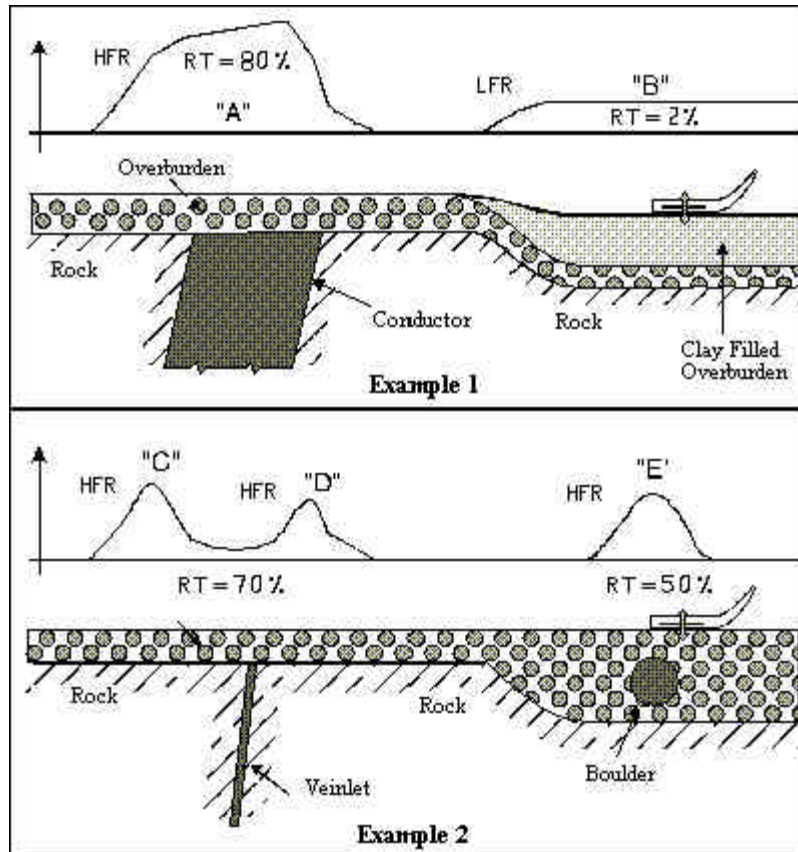

Illustration 10: Examples of typical profiles of the *Beep Mat*

Here is how to interpret illustration 10:

- Anomaly "A" is strong and wide, and the ratio (Rt) is high. It indicates the presence of a good wide conductor. Compare with illustration 9.
- Anomaly "B", however, is weak and uniform, and the ratio (Rt) is low; it is a typical sign of the effect of a clayey ground.
- Examine anomalies "C" and "D" of example 2 above. These two anomalies forming a doublet are both caused by the effect of an almost vertical veinlet. Compare with cases "a" and "b" of illustration 11. There are no anomaly above the veinlet because the induction lines (see chapter 4) do not cross it (illustration 11, case "b"). For more explanations, see also illustration 14, at section 7.3.
- Anomaly "E" is rather narrow and reacts mostly in HFR. In this example, it is due to the presence of a boulder in the till.

Do not attach too much importance to the exact shape of these profiles. When you will pull the *Beep Mat* again, the profile should change in its details. This is due to one or several of the following factors:

- the probe has not been pulled exactly on the same line;
- the surface is bumpy;
- the surface condition has changed (for example, before and after rain).

The *Beep Mat* is adapted for quick jobs. Experience will make you able to visualize these profiles by memory while delimiting an interesting target. It is faster and more efficient to pass the *Beep Mat* again and delimit the target with flag tape, then dig and sample, than to draw a survey profile on paper once back at the office.

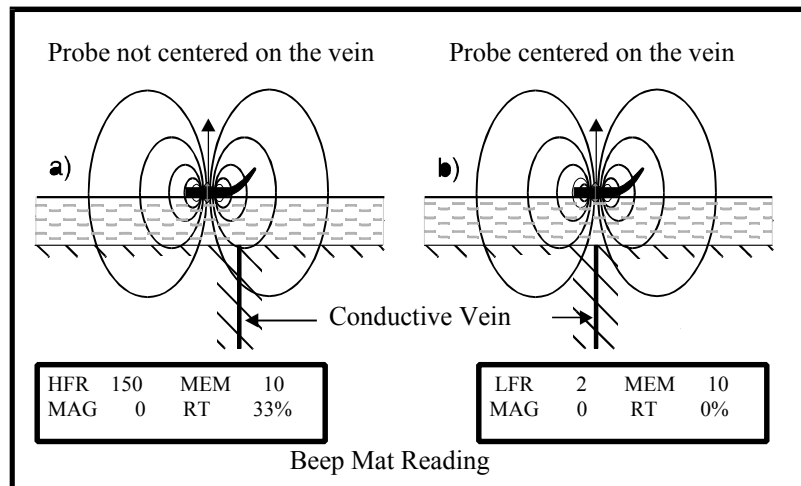

Illustration 11: Explanation of typical *Beep Mat* anomalies

7. PRACTICAL APPLICATIONS

As mentioned previously, it is essential, before doing a *Beep Mat* survey, to elaborate a strategy in order to maximize the chances of making a discovery. When a *Beep Mat* anomaly appears in the field, you must then use appropriate tactics.

7.1 Strategy

Look for a favourable ground for a *Beep Mat* survey, such as an area where the overburden is not very deep (less than 2 meters) and contains, if possible, electromagnetic anomalies. Use the following published maps:

- Overburden maps (M.R.N. in Quebec)
- Quaternary geology maps (Geological Survey of Canada)
- Geology maps for outcrops
- Electromagnetic and magnetic airborne survey maps
- Topographic maps (at 1:20,000 or 1:50,000)
- Aerial photos
- Compilations of previous works

Prepare a strategic map for your survey, similar to the one shown on illustration 12. You can use the overburden map as a starting point. Report all pertinent information on that strategic map. Mark all outcrops, boulders, conductors (electromagnetic anomalies) and/or magnetite concentrations (not very deep magnetic anomalies), known geological directions, areas where the overburden is less than two meters thick, areas covered with till rather than with river deposits (sand, clay), etc. Make sure that the elements coordinates are as precise as possible. Finally, delimit target areas to be explored and estimate the direction of the survey lines.

Former prospectors have taught us that lake shores and swamp edges (former lakes) very often represent favourable areas for prospecting because waves have washed the till and bare rocks are often hidden just under a thin layer of moss.

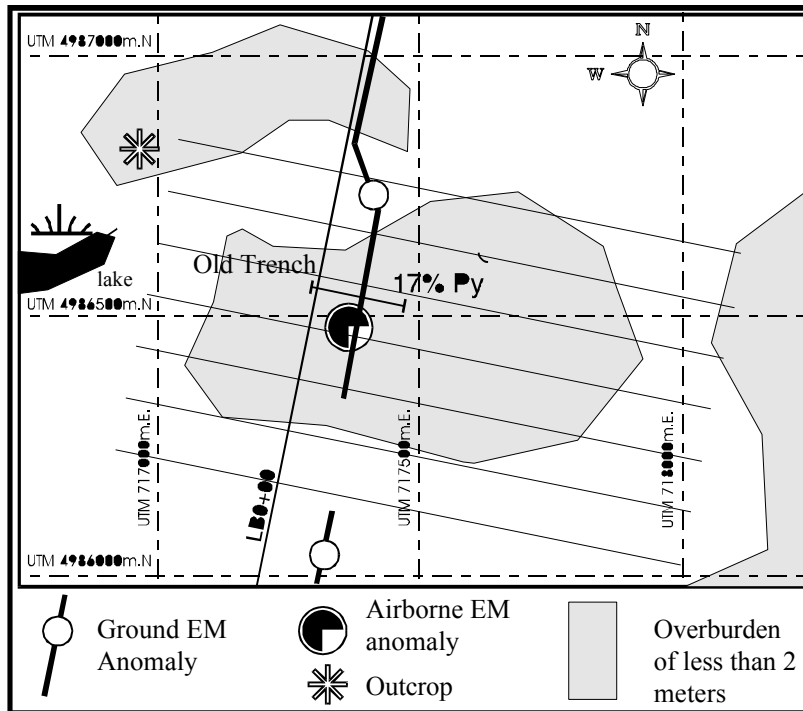

Illustration 12: Simplified example of a strategic map

Once in the field, at the beginning of the survey, try to evaluate the operating parameters of the *Beep Mat*. Modify them if you find it appropriate. You may also want to modify these parameters in order to reduce the alarms frequency. Cover target areas according to your strategic map. Use the *Beep Mat* to localize known conductors, discover new conductors or detect mineralized boulders.

7.2 Advanced Tactics

If you detect an anomaly, reinitialize the *Beep Mat* and pass it again on this anomaly, it should beep again. With a post, flag tape, etc., mark the spot where the highest value was obtained. Keep that value in mind. Zigzag around the spot taking into account the conductor's direction or the geological direction (see illustration 13). With colored flag tape, delimit the anomaly contour, its size and other spots having high values. Check if this anomaly appears again farther in the same geological direction. If you do not find the conductor, you can use a MAG VLF to localize its axis, then zigzag with the *Beep Mat* over the known *Beep Mat* axis to find where the conductor comes closer to the surface. But remember that any conductor that a *Beep Mat* detects may lead to the discovery of a mine, even if the VLF had not reacted to it! So maximize your time by pulling the *Beep Mat* instead of running a VLF survey.

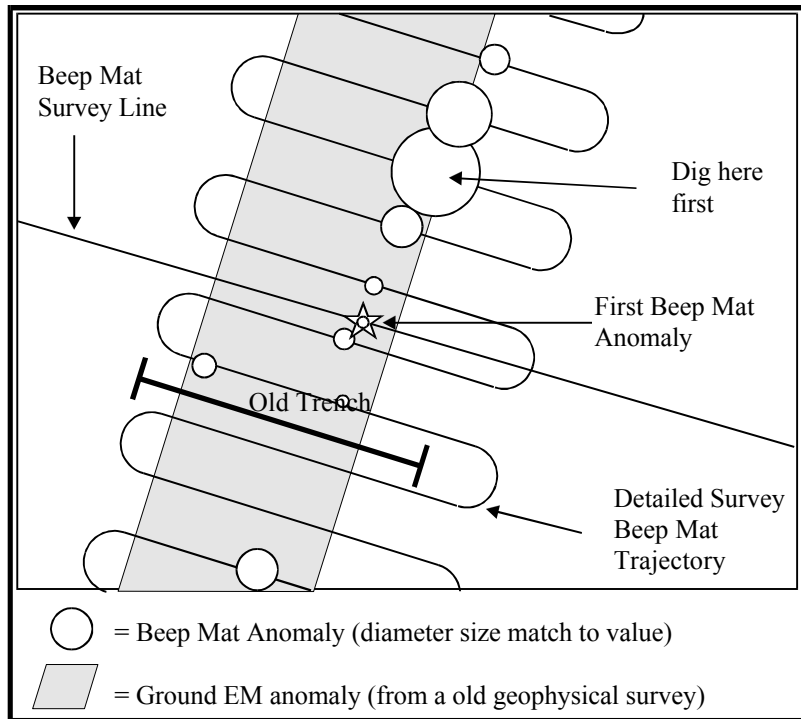

Illustration 13: Practical approach with a *Beep Mat* to localize a conductor

By concentrating your efforts on the areas which give the highest values, you will not have to dig too much since a high value means that the conductor is closer to the surface. Dig until you can identify the source of the anomaly (graphite, sulfite or even native metal). If the conductor seems to be deep, dig and check if the readings increase when you insert the probe into the hole. If the readings increase, it means that you are really getting closer to the conductor. Take samples containing sulfides for assays (Cu, Zn, Pb, Au, Ag, Ni, etc.).

Repeat these steps for each conductor discovered with the *Beep Mat*.

7.3 Case of Anomalies Forming a Doublet

If you find two *Beep Mat* anomalies along your route and they are in a doublet (about 1 meter apart), it is possible that you may be dealing with only one veinlet located in the middle rather than with two (see illustration 10, anomalies "C" and "D"). Determine the conductor axis, then grab the probe and hold it on its side as shown on illustration 14. Its induction axis should therefore be horizontal and perpendicular to the geological orientation. Cross the anomalies with the probe thus oriented. You might find only one anomaly in the middle. That is where you must dig. If both anomalies persist, dig at both places.

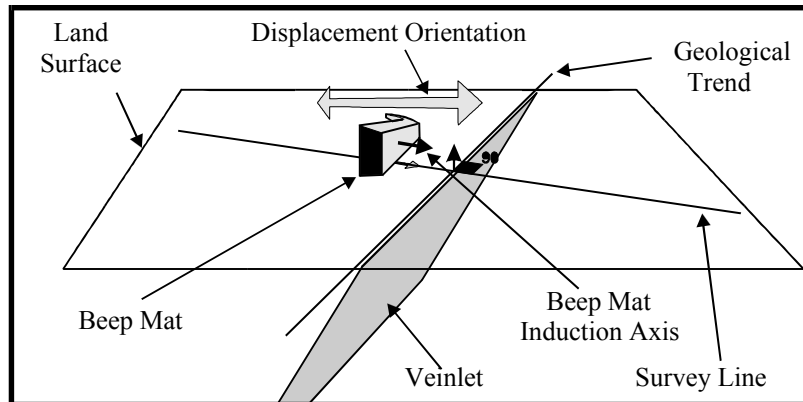

Illustration 14: Confirming double anomalies

7.4 Sampling

On a given long conductor, it is suggested to take a sample at every 300 or 400 meters (and send them for assays) since even a barren pyrrhotite horizon can turn out to be, for example, a rich ore (ex.: Thompson Mine in Manitoba). However, on parallel horizons, it is suggested to sample whenever the conductor's nature changes (graphite to pyrite) and wherever the geological environment is favourable (fine pyrite in quartz veinlets). By cleverly choosing their sampling sites, *Beep Mat* users will make more discoveries. Thanks to the *Beep Mat*, a massive sphalerite horizon was once discovered about 10 meters from a sterile pyrite trench.

7.5 Clayey Grounds

On a weak and uniform target, if you suspect that the ground is particularly conductive (clayey ground), you can dig if you feel like it a 30 -cm deep trench that is big enough to insert the probe in it. Put the probe into the hole and rotate it to find out from what direction the strongest signal is coming. If the displayed values do not vary much, it is due to the clayey nature of the ground. But if the values increase, it means that the conductive rock is hidden deeper. If the values keep increasing while the probe is in the hole, keep digging up to one and a half meter. Usually, clayey grounds are uniformly flat and give a relatively uniform LFR value (between +25 and +80) on a large surface. The ratio (Rt) value should be very low on clayey ground, indicating a poor conductor.

8. TRUE AND FALSE SIGNALS

Here are a few examples of true and false signals that you will learn to recognize by experience.

8.1 *Probe Frequency Drift*

When the probe frequency drifts, as during the preheating period, the (L/H)FR value may well increase and the alarm will go off. Before digging, reinitialize the probe in the air to correct the drift. If the alarm stops once the probe is back on the ground, continue your survey, it was a false alarm caused by the drift of the probe. But if the *Beep Mat* still beeps, it means that it is a true signal and you can dig.

8.2 *Drifting and Ground Proximity*

If the probe has started to drift and is on humid ground, the water effect may prevent it from beeping. However, as soon as the probe moves away from the ground (ex: when passing over a log), the reading unit will beep. Lift the probe in the air and if it still beeps, reinitialize it. In both cases, pass the probe again at the place where it beeped to check if there really was a conductor at that place.

8.3 *How to Interpret Beep Mat Signals in Clayey Areas*

Clay layers deposited in brackish waters during one of the ice -age periods are sometimes somewhat conductive. On these clay layers charged with water, the (L/H)FR value displayed by the probe laid on the ground will be close to zero, the effect of clay conductivity being cancelled by the effect of water, and the reading unit will probably not beep. However, if you pass over a log lying on the ground while walking with the probe, the probe will leave the ground. The effect of water will rapidly diminish, but the clay conductivity, which slowly diminishes with distance, will make the LFR value rise to 80, and the *Beep Mat* will signal a conductor. Remember that on clayey ground, the conductor value LFR does not vary because this type of ground is not very conductive.

8.4 *Salt in the Ground*

Salt water is highly conductive. You might detect conductors caused by salt next to roads on which de-icing salt has been spread during winter.

9. INTERPRETATION OF VALUES

The *Beep Mat* gives a quantitative measure of the apparent conductivity and/or the average magnetite content of the underlying rock. It also gives an estimate of the intrinsic conductivity thanks to the ratio value (Rt).

9.1 Magnetite Content

The magnetite content is measured on a 1-m^3 volume under the probe. Our testing indicates that a MAG value of $-1,000$ corresponds to 1% magnetite under the probe, which is equivalent to about $-1,000$ gammas for a volume of a few meters cubes. This equivalence exists up to a magnetic value of $-20,000$, which is equivalent to 20,000 gammas, or 20% magnetite.

9.2 Apparent Conductivity

Up to now, the apparent conductivity has been calibrated only in the absence of magnetite. The graph presented on illustration 15 (curve "a") shows the apparent conductivity according to the (L/H)FR value and in the absence of magnetite. Caution! A veinlet or a coin will suggest a bad conductivity, because the instrument measures the average conductivity of the area surrounding the probe. However, the instrument gives a real measure of the conductivity of a clay layer. The closeness of water creates a negative signal. The estimate of the conductivity of a clay layer full of water is slightly more real if one lifts the probe 10 cm above the ground because the influence of water, just as the influence of magnetite, diminishes more rapidly than the effect of the conductor (see curves "b" and "c" of illustration 15).

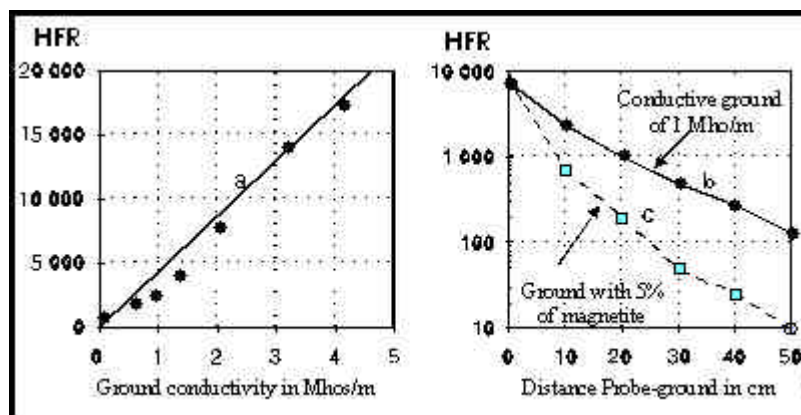

Illustration 15: Factors influencing the HFR value

9.3 *Intrinsic Conductivity*

In the absence of magnetite (verify with a magnet), the Rt (ratio) gives a measure of the intrinsic conductivity of the conductor and this ratio is not influenced by the size of the conductor. Therefore, a coin placed on the testing point (the first "D" of "GDD") will give HFR values ranging from +70 to +80, while a typical Abitibi clay layer will also give a HFR value of +80, and therefore a Rt close to 0%. Remember that the ratio value will be calculated only if the HFR is at least 10 and if no magnetite is present (MAG = 0).

9.4 *Variation of Sulfides Conductivity*

As mentioned before, galena and compact massive pyrite are not always conductive. One does not know why these variations exist, but since these sulfides are semiconductors, it could depend on the impurities incorporated in the crystals structure, as for transistors! Fortunately for the *Beep Mat* and prospectors, pyrite veinlets, which are often present in gold-bearing quartz veins, are generally good conductors. This has been noticed in particular on gold-bearing quartz veins that do not react to any other geophysical instrument and that can be discovered under moss only by the *Beep Mat* or a trench.

10. DATA TRANSFER

To better understand this chapter, one must be familiar with microcomputers (in particular PC compatibles), communication softwares and serial ports (or modems).

Connect the reading unit to a computer as shown below.

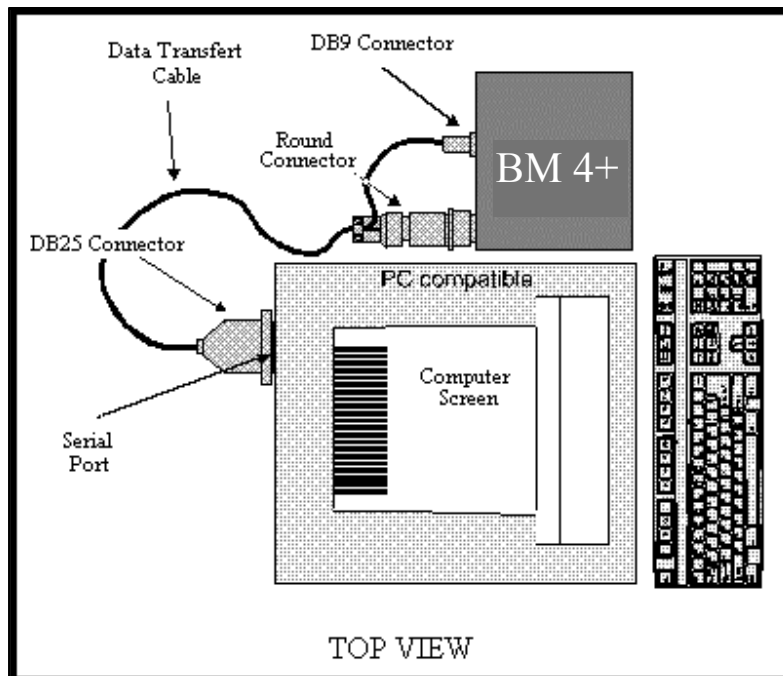

Illustration 16: Connections for a data transfer

Turn your communication software on and press [ON]. Note the instructions on the BM4+ display. Here is an example:

Baud = 4,800 Parity = N MEM
Length = 8 Stop bit = 1 12

Make sure that the communication software be according to the instructions on the screen of your computer and verify the serial port used (ex.: COM1). The [carriage return] (CR character) must be added by the communication software. Press on "**Enter**" or "**CR**" depending on the type of keyboard you use. The message shown on illustration 17 should appear on the screen of the computer:

```
BM4+ by Instrumentation GDD Inc.

MENU ->  DUMP(memory_start, memory_end)
          Set your software in capture mode,
          then send the DUMP command

          CLEAR
          Clear all memory of the BM4+

GDD >
```

Illustration 17: Message of a data dump displayed on the computer

This menu presents two choices: data transfer (**DUMP** command) and memory clearing of the *Beep Mat* (**CLEAR** command). Characters in **bold** indicate the ones you must type on your keyboard. Note that there is no spacing between the typed characters.

If you want to transfer the data, put the communication software on "capture", then type:

DUMP(0,12) and press on "**Enter**" or "**CR**"

A message similar to the one shown on illustration 18 should appear on the screen. In the example presented on illustration 18, you have stored 12 readings including initializations, so a sequence of 13 data are transferred (data #0 to #12).

On illustration 18, the first column indicates the memory number. As you can see, that number increases by one, from one row to the other. The other three columns are respectively (L/H)FR, MAG and Rt. Note the following points:

- In the field, Rt was ***. Once dumped, it is replaced by -1 (memories 0, 1, 2, 9 and 11).
- Memories 7, 8 and 10 are missing since they correspond to initializations.
- The last memory (12) contains only zeroes, indicating an empty memory.

GDD> DUMP(0,12)			
Memory	(L/H)FR	MAG	Rt
0	7	-5	-1
1	25	-5	-1
2	28	-5	-1
3	141	0	50
4	132	0	41
5	45	0	22
6	48	0	92
9	141	-53	-1
11	3	-2	-1
12	0	0	0

Illustration 18: Typical display following a data dump

After the data transfer, you will eventually want to clear the BM4+ memory to leave space for other readings. In order to do so, type **CLEAR** to see the display shown on illustration 19. This will clear the 3300 memory space of the *Beep Mat*, so next time you use the *Beep Mat*, the MEM value should be at 0 or 1.

```

GDD > CLEAR

WARNING !!!  ALL DATA WILL BE LOST...
              CONFIRM WITH (9999) ? 9999

PLEASE WAIT...
CLEAR MEMORY COMPLETED...
GDD >

```

Illustration 19: Display for the memory clearing of the BM4+

Beep Mat, model BM4+

Trademark

Beep Mat is a trademark by *Instrumentation GDD Inc.*

Copyright

Considering GDD's interest in promoting the *Beep Mat*, any person interested in duplicating this manual is authorized to do so.

Warranty

Duration of warranty: One year. All repairs will be done free of charge at our office in Québec (taxes, transportation and customs fees are extra). The warranty is void if the instrument has been the object of an abusive use, has been opened or modified without authorization, or if the serial number of the instrument has been altered, erased or removed.

Instrumentation GDD Inc. is not responsible for any eventual damages and/or losses that may occur during transportation or use of the *Beep Mat*.

Repairs

Should the *Beep Mat* require repairs, please contact *Instrumentation GDD Inc.* at the numbers below in order to receive proper instructions for shipping.

- Tel.: 418-877-4249
- Fax.: 418-877-4054
- E-mail: gdd@gddinstrumentation.com